

Setup and Operation



HV-2000 Jet

Diaphragm-Jet™ Technology

3A5855A

EN

**For non-contact dispensing of viscous material in industrial environments.
For Professional Use only.**



Important Safety Instructions

Read all warnings and instructions in this manual and all related manuals before using this equipment. Save these instructions.



Table of Contents

Related Manuals	3
Safety Guidelines	4
1. Introduction and Specifications	5
1.1 Advanjet HV-2000 Jet Overview	5
1.2 HV-2000C Jet Controller (Optional)	5
1.3 HV-2000 Jet Specifications	6
1.4 Technical Assistance	6
1.5 HV-2000 Jet Dimensions	7
2. Installation and Setup	8
2.1 Dispensing Components	8
2.2 Pneumatic System	9
2.3 Electrical Interface – Controller	10
2.4 Jet Cable Input/Output	11
3. Assembling the HV-2000 Jet	12
3.1 HV-2000 Jet Assembly Overview	12
3.2 Electrical and Pneumatic Connections	13
3.3 Inspect the Nozzle Plate for Cleanliness.....	13
3.4 Install a Nozzle Insert (Optional).....	14
3.5 Install the Diaphragm and Nozzle Plate	15
3.6 Install the Fluid Syringe.....	17
3.7 Prime the Jet.....	18
3.8 Check for Fluid Leaks	20
4. Cleaning the Jet	21
4.1 Cleaning the Exterior of the Jet.....	21
4.2 Cleaning the Interior of the Jet.....	21
4.3 Clean the Nozzle and Nozzle Plate	23
Graco Standard Warranty	24

Related Manuals





Manuals are available at www.graco.com. Component manuals below are in English:

3A5856	HV-2000C Jet Controller Setup and Operation
3A5937	Jet Dispensing Parameters Supplement
3A5908	Advanjet Jet Maintenance Tool Kit (JKT-2000)
3A5909	HV-2000 Maintenance and Repair

Safety Guidelines

Hazards may arise if handled improperly by unqualified personnel. It is recommended that operating personnel thoroughly review these operating instructions.

The following warnings are for the setup, use, grounding, maintenance, and repair of this equipment. The exclamation point symbol alerts you to a general warning and the hazard symbols refer to procedure-specific risks. When these symbols appear in the body of this manual or on warning labels, refer back to these Warnings. Product-specific hazard symbols and warnings not covered in this section may appear throughout the body of this manual where applicable.

 WARNING	
	<p>ELECTRIC SHOCK HAZARD This equipment must be grounded. Improper grounding, setup, or usage of the system can cause electric shock.</p> <ul style="list-style-type: none"> • Turn off and disconnect power cord before servicing equipment. • Connect only to grounded electrical outlets. • Use only 3-wire extension cords. • Ensure ground prongs are intact on power and extension cords.
	<p>TOXIC FLUID OR FUMES HAZARD Toxic fluids or fumes can cause serious injury or death if splashed in the eyes or on skin, inhaled, or swallowed.</p> <ul style="list-style-type: none"> • Read Safety Data Sheets (SDSs) to know the specific hazards of the fluids you are using. • Store hazardous fluid in approved containers, and dispose of it according to applicable guidelines.
	<p>BURN HAZARD Equipment surfaces and fluid that is heated can become very hot during operation. To avoid severe burns:</p> <ul style="list-style-type: none"> • Do not touch hot fluid or equipment.
	<p>PERSONAL PROTECTIVE EQUIPMENT Wear appropriate protective equipment when in the work area to help prevent serious injury, including eye injury, hearing loss, inhalation of toxic fumes, and burns. Protective equipment includes but is not limited to:</p> <ul style="list-style-type: none"> • Protective eyewear, and hearing protection. • Respirators, protective clothing, and gloves as recommended by the fluid and solvent manufacturer.

1. Introduction and Specifications

1.1 Advanjet HV-2000 Jet Overview

Advanjet HV-2000 non-contact jetting technology is a major leap in liquid dispensing. The jet valve features Advanjet's patented diaphragm design: a single, easily replaceable diaphragm eliminates the many dynamic fluid seals common in all other jets. The inherent advantages of this design are significant:

- The diaphragm's very low mass allows very fast cycle rates since there is not a large sliding valve stem to slow down the process.
- With the novel diaphragm design, the energy needed to eject a drop can be adjusted, providing wider process windows. As a result, the HV-2000 can dispense a wide range of fluids and applications.
- The non-contact jetting is fast, allowing dispensing rates up to 300Hz.
- Drop size can be adjusted $\pm 20\%$ from the nominal size, allowing a wide range of adjustability.
- The simplicity of the Advanjet diaphragm design is most beneficial in its ease of cleaning, since the two parts that touch the fluid are quickly and easily removed for cleaning/replacement.

1.2 HV-2000C Jet Controller (Optional)

Designed for the HV-2000 Jet Valve, the HV-2000C Jet Controller provides timing signals as well as pneumatic and electrical resources for the Advanjet HV-2000 Jet Valve.

- The HV-2000C provides timing signals to drive a rapid-response solenoid valve in the HV-2000 Jet Valve. Its internal computer remembers and executes a variety of operational sequences. The controller can respond to actuation signals from either a front panel switch or from an external switch.
- The HV-2000C provides regulated, pressurized air for the fluid pressure and jet pressure of the HV-2000 Jet Valve.
- The HV-2000C provides electrical power to a heater element in the HV-2000 Jet Valve, and controls the temperature of the valve's heater by monitoring a resistance temperature detector (RTD) sensor in the HV-2000 Jet Valve.

1.3 HV-2000 Jet Specifications

PARAMETER	SPECIFICATION
Size HV-2000 Jet (without mounting bracket)	Width: 25.4 mm (1.00 in) Height: 90.3 mm (3.56 in) Depth: 82.0 mm (3.23 in) Weight: 348 grams (0.77 lb)
Viscosity Range	1-400k mPa-s (cps)
Fluid Syringes	5, 10, 30 and 55 cc
Nozzle Sizes	
Standard (Flat) Ceramic [1.6 mm]	75 µm, 100 µm, 125 µm, 200 µm
Standard (Flat) Carbide [1.6 mm]	50 µm, 64 µm, 75 µm, 100 µm, 125 µm, 150 µm, 200 µm, 300 µm, 400 µm
Standard (Flat) Carbide [3.0 mm]	64 µm, 75 µm, 100 µm, 125 µm, 200 µm, 300 µm, 450 µm
3 mm Capillary ST Carbide [1.6 mm]	75 µm, 100 µm, 125 µm, 200 µm
3 mm Capillary ST Carbide [3.0 mm]	75 µm, 100 µm, 125 µm, 200 µm
6 mm Capillary Carbide [1.6 mm]	75 µm, 125 µm, 200 µm
6 mm Capillary ST Carbide [3.0 mm]	75 µm, 100 µm, 125 µm, 200 µm
Nozzle Heater	Heating: 70 °C (158 °F) Max
Fluid Pressure	0.27 MPa (40 psi) Max
Jet Pressure	0.24 MPa (35 psi) Min, 0.62 MPa (90 psi) Max
Controller Interface	RS-232 and LCD Display with Keypad
Power Input	See manual 3A5856, HV-2000C Jet Controller Setup and Operation
Input/Output	TTL level triggers
Operating Temperature	10 °C to 50 °C (50 °F to 122 °F)
Wetted Parts	Tungsten carbide, stainless steel, ceramic (zirconium dioxide), FKM, silicone, FFKM, EPDM

1.4 Technical Assistance

For technical assistance:

Phone: +1 760-294-3392

Web: www.advanjet.com

E-mail: info@advanjet.com

1.5 HV-2000 Jet Dimensions

Shown below are the mechanical dimensions of the HV-2000.

- The HV-2000 can be mounted to a variety of robots when X-Y-Z motion is desired. It can also be mounted rigidly over a transporting mechanism like a conveyor belt or shuttle table.
- The HV-2000 provides mounting holes located on the rear mounting plate for rigid attachment to a robot's X-Y-Z stage. Additionally, the rear mounting plate allows the jet to be mounted in a channel which allows adjustment of the dispense tip to the dispensing surface.
- The dispense tip relative to the mounting holes and the rear mounting plate dimensions are shown in mm in the figure below. It is highly recommended that any mounting scheme allow for vertical adjustment so the dispensing tip to dispensing surface can be easily adjusted.

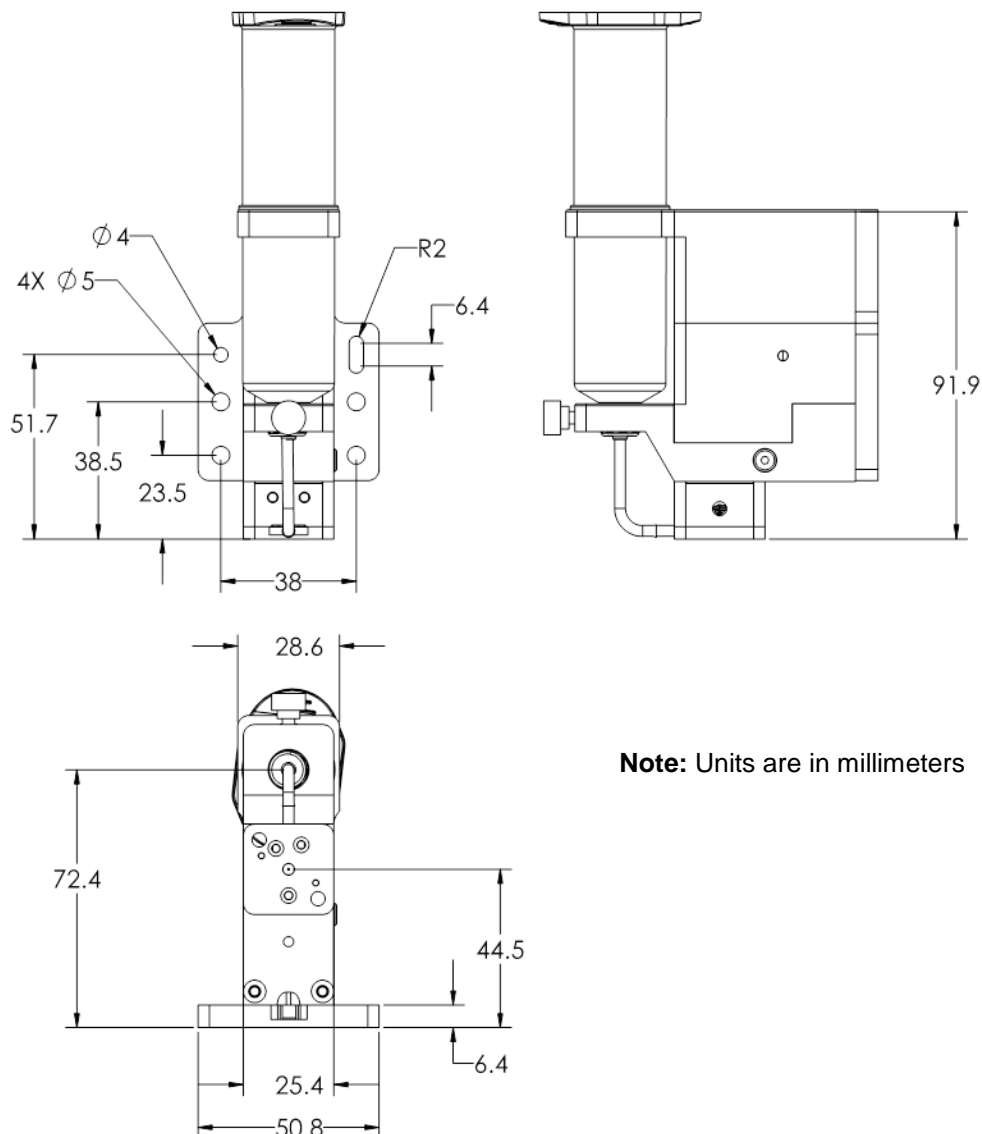

Note: Units are in millimeters

2. Installation and Setup

2.1 Dispensing Components

As illustrated in Figure 2-1 below, the HV-2000 has three components in contact with the fluid: the nozzle plate, diaphragm, and the feed tube. The materials of these components are listed in the table below. These components can be easily disassembled with two screws, cleaned, and reused. Cleaning procedures are in Section 4 - Cleaning the Jet. The diaphragm should be inspected each time the nozzle plate is removed. If there are signs of wear, cracks, or deformation, the diaphragm should be replaced.

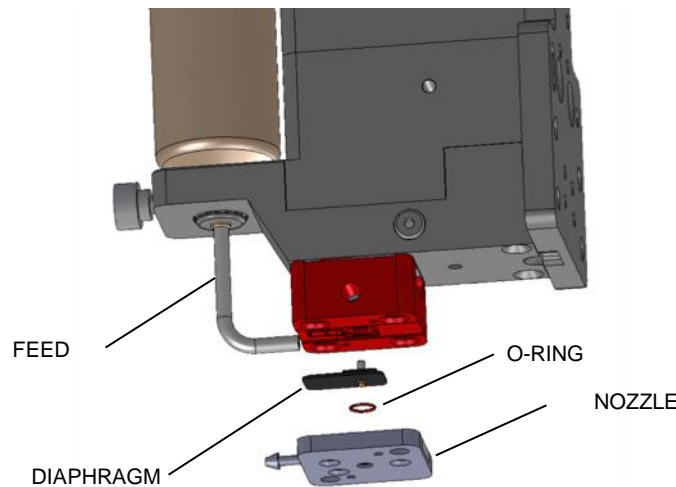

Figure 2-1: HV-2000 Jet Dispensing Components

NOTICE

Fluids that could damage the jet's wetted parts (17-4 Stainless Steel, Tungsten Carbide, Ceramic, FKM, FFKM, and Silicone) should not be dispensed or used for cleaning.

Not recommended are pre-mixed 2-part adhesives with a short pot life as these can harden in the nozzle plate.

Cyanoacrylates are not recommended.

2.2 Pneumatic System

NOTICE

It is imperative that the air supplied to the HV-2000 Jet Valve is clean, dry and free from debris and water. A 40-micron filter, a water separator, and an overpressure relief valve set at around 120 psi (0.83 MPa) are highly recommended. If the air is not clean and dry, serious damage can occur to the solenoid valves. The air supply pressure should be between 70 and 100 psi (0.48 and 0.70 MPa).

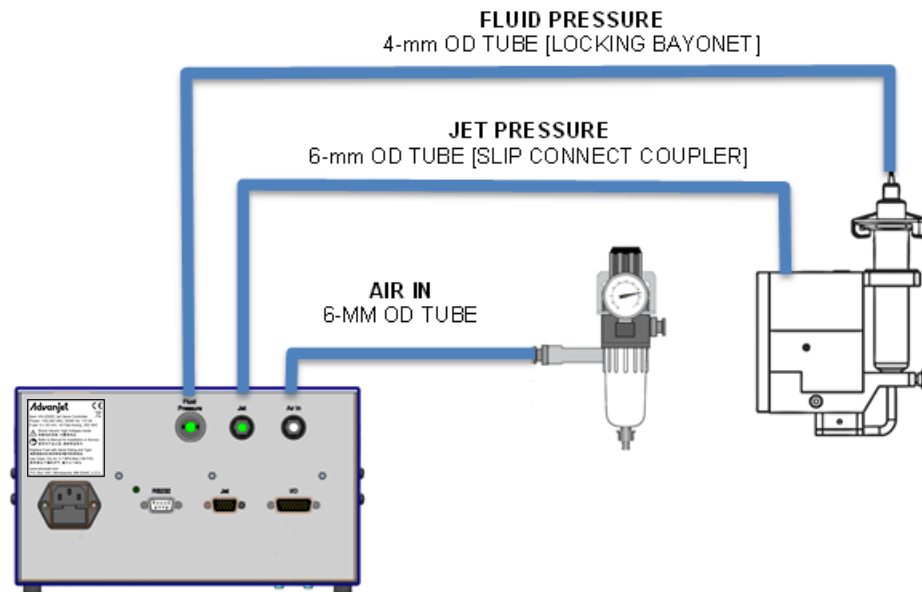

Figure 2-2: HV-2000 Pneumatic Connections
(Shown with the HV-2000C Controller)

Referring to Figure 2-2, connect an independently regulated and filtered main air source (at least a 40-micron filter) to the jet. The air supply must be clean and dry and at a pressure of 70 to 100 psi (0.48 to 0.70 MPa). Normal jet air operation is usually between 40 and 60 psi (0.28 and 0.41 MPa). The HV-2000 Jet Valve is supplied with a 6 mm OD air tube and terminates with a slip connect coupler.

The HV-2000 is supplied with a syringe mount that can accommodate a 30 cc or 55 cc syringe. Adapters are available for 3 cc, 5 cc, and 10 cc syringes. A receiver head attaches to the syringe. If a syringe is not desired, fluid can be connected directly to the feed tube using a luer lock connector. Maximum fluid pressure is 40 psi (0.28 MPa). However, normal operation is usually between 5 and 30 psi (0.05 and 0.28 MPa). Pressure variations in the fluid pressure source can adversely affect the consistency of the drop size.

2.3 Electrical Interface – Controller

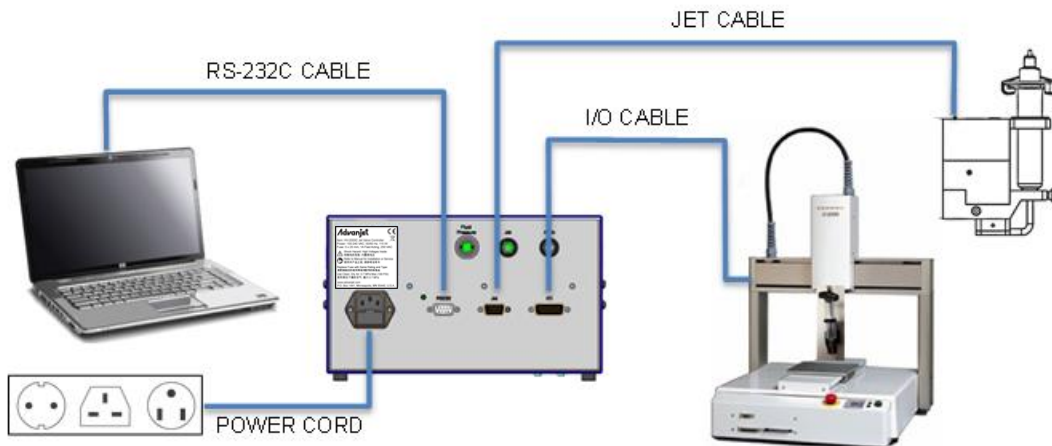

Figure 2-3: HV-2000 Cable Connections (Shown With HV-2000C)

Four cable connections are on the rear of the Advanjet controller: power cord, RS-232, jet, and digital I/O, as shown in Figure 2-3. To ensure proper connections to the Advanjet controller, each of the standard cables supplied by Advanjet has a distinct connector.

NOTICE

To prevent unintended dispensing, be sure that all power is off when connecting or disconnecting cables from the Advanjet controller.

Power: The power cord set includes a standard 3-wire cable (hot, neutral, ground) with an IEC C13 straight International female connector on one end and a country-specific plug at the other end. Advanjet is prepared to supply cord sets for the USA, for the UK (part no. 121057), and a standard Euro connector (part no. 121056).

RS-232: The Advanjet software requires an RS-232C communication interface with the Advanjet controller. If your computer does not have an RS-232C port, use a USB to RS-232C converter cable with the drivers that come with the cable. Advanjet can supply an RS-232C-to-USB cable and corresponding driver.

Jet: The Jet cable is a high-density HD-15 cable and should be attached directly to the HV-2000 Jet and the controller. See Section 2.4 for more details.

I/O (for HV-2000C): The robot's controller uses the input/output cable to trigger the HV-2000 to fire the sequence of drops programmed into the Advanjet controller. The I/O cable should be connected directly to the host robot's controls. A male DB-26 connector is required to interface with the I/O cable. The Advanjet controller has an internal nonvolatile memory that retains the jet parameters that were downloaded into the controller. The controller provides 6 TTL trigger lines to control jet operations.

2.4 Jet Cable Input/Output

A 15-pin cable is supplied with the HV-2000 Jet Valve. The table below describes the Jet cable pin assignments.

- Pins 2 and 7 are for the solenoid.
- Pins 10 and 13 are for the heater.
- Pins 11, 14, and 15 are for the RTD. Pins 11 and 15 are jumped internally in the cable.



STANDARD HD-15 JET CABLE PIN ASSIGNMENTS	
PIN	
1	--
2	Solenoid
3	--
4	--
5	--
6	--
7	Solenoid
8	--
9	--
10	Heater
11	RTD (internally jumped to pin 15)
12	--
13	Heater
14	RTD
15	RTD (internally jumped to pin 11)

3. Assembling the HV-2000 Jet

The HV-2000 Jet Valve is shipped fully assembled except for a diaphragm and nozzle plate. A specific diaphragm material and nozzle plate orifice diameter should be chosen based on the application and dispensing fluid. Refer to the Jet Dispensing Parameters Supplement manual 3A5937. The steps required to correctly assemble the diaphragm and nozzle plate on the jet body are listed below.

3.1 HV-2000 Jet Assembly Overview

Figure 3-1 below shows the fit and alignment of the HV-2000 Jet Valve heater block, diaphragm, o-ring, and nozzle plate.

- There is a grooved pattern on the bottom face of the heater block that matches the raised embossments on the diaphragm. The grooves position the diaphragm correctly on the heater block.
- The diaphragm also has a metal insert with a post that must be inserted into the central hole on the heater block.
- Although a diaphragm can be inserted without the jet connected to an air source, it will not sit flat on the heater. It is recommended to connect the jet valve to the HV-2000C (or the user's controller) and set the jet to OPEN before assembling the diaphragm. Detailed instructions are in Section 3.5.

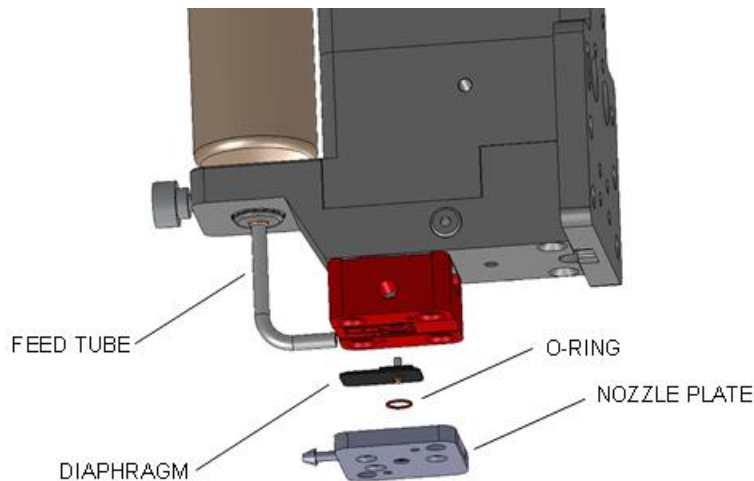

Figure 3-1: HV-2000 Heater Block, Diaphragm, O-ring and Nozzle Plate

The following sections provide detailed instructions for assembling the HV-2000 Jet. References to the HV-2000C Jet Controller are used for illustrative purposes.

NOTICE

It is important that the nozzle plate and diaphragm are clean and free of debris before installing onto the jet. If the nozzle plate is not clean, it could affect the dispensing quality or, in the worst case, could plug the nozzle orifice.

3.2 Electrical and Pneumatic Connections

Before assembling the jet, make the necessary pneumatic and electrical connections to the jet controller as described in Sections 2.2 and 2.3.

3.3 Inspect the Nozzle Plate for Cleanliness

It is important to inspect the nozzle plate for debris before mounting it onto the Jet. If the nozzle plate is not clean, it could affect the dispensing quality. These dispensing problems are symptoms of a contaminated jet:

- Unclean or uneven dispensing.
- Drops become irregular or vary in size.
- Residual flow or drooling out of the tip when the jet is in the closed position.
- Interrupted dispensing (places where fluid no longer is dispensed).
- Splatter or satellites.

In the worst case, contamination could plug the nozzle orifice, as pictured in Figure 3-2.

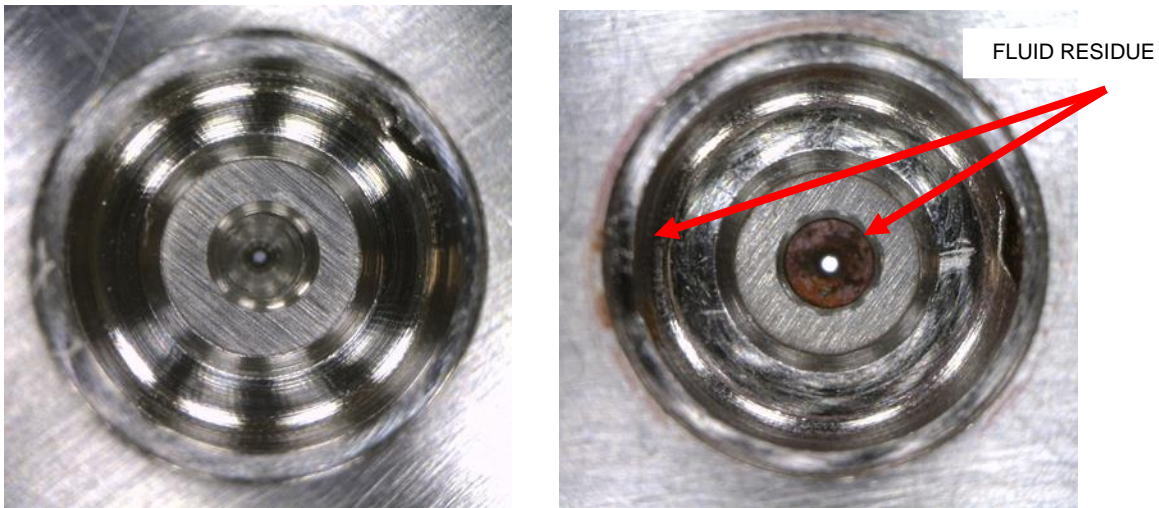

Figure 3-2: Clean Nozzle (left) Compared to Contaminated Nozzle (right)

To avoid damage to the jet, Cleaning Kits contain tools appropriately sized to the nozzle plate. For example, for the 125 μm nozzle plate, order the 125 μm cleaning kit, Advanjet part number CL-125.

Refer to Section 4 - Cleaning the Jet for complete instructions.

NOTICE

Never submerge the diaphragm in solvents as they might be damaged.

Diaphragms can be cleaned successfully with a small amount of solvent and a soft brush and cotton swab.

Do not submerge the diaphragm into the ultrasonic cleaner because it will deteriorate the diaphragm and shorten its life.

3.4 Install a Nozzle Insert (Optional)

When the nozzle becomes damaged or plugged, a new nozzle insert may be required. Installation is simple, but correct and careful assembly is important.

NOZZLE PLATE O-RING P/N		NOZZLE INSERT O-RING P/N	
SILICONE	FKM	SILICONE	FKM
NP09-2820	NP09-2850	NP09-2830	NP09-2851

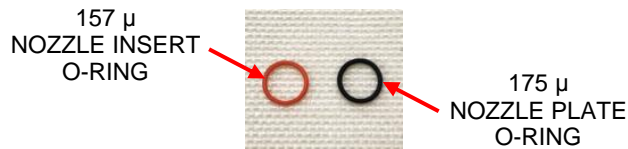

Nozzle Insert O-Ring (left) Compared to Nozzle Plate O-Ring (right)

1. Disassemble the nozzle plate by removing the 3 screws from the nozzle plate bottom.
2. Flip over and remove the nozzle plate top and the nozzle insert. Save the o-ring.
3. Clean as needed.

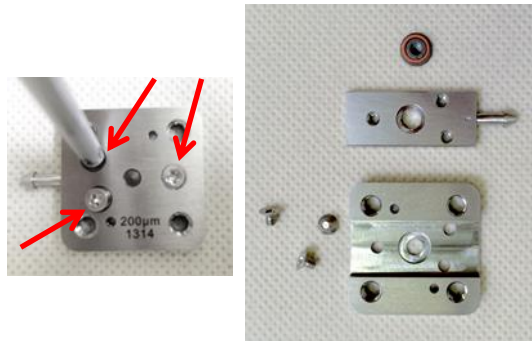

4. Mount the nozzle insert o-ring.

Note that the o-ring for the insert is smaller than the o-ring for the nozzle plate.

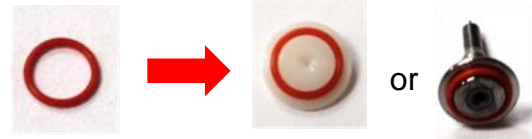

5. Set the nozzle insert tip down on the inside face of the nozzle plate bottom. Replace the nozzle plate top and insert and tighten the three screws.

6. Set the nozzle insert with the o-ring facing up in the groove of the bottom plate as shown to the right.

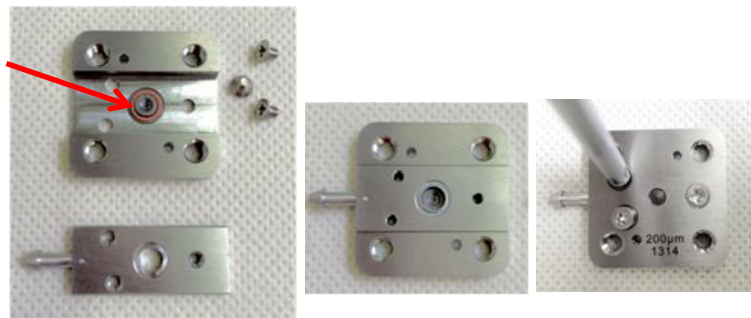

7. Replace the nozzle plate top. Holding the top and bottom plates together, flip the nozzle over. Replace the 3 screws.

8. Flip the nozzle top side up and set the nozzle plate o-ring in the groove.



Note: When installing the nozzle, the o-ring must face **up**.

3.5 Install the Diaphragm and Nozzle Plate

Note: The following procedures refer to the HV-2000C front panel functions.

Attach the pneumatic and electrical connections as described in Sections 2.2 and 2.3. Set the Jet Pressure to 40 psi (0.28 MPa) and the Jet Value to OPEN, as illustrated below:

1. Turn the **Fluid Air** OFF (press “O” on **Air** switch) and turn the main power ON (press “I” on **Power** switch).



2. Set the **Jet Pressure** to 40 psi (.28 MPa).
 - First, turn the knob down to below the set value.
 - Then, turn up slowly until the desired value is reached.
 - Adjust to ± 1 psi.

It is best not to overshoot the value; start below the set value and always “turn up.”



3. Press the ← or → key until the cursor blinks at the **Jet** position, and toggle the ↑ key to OPEN the jet (a puff of jet actuation should be heard).

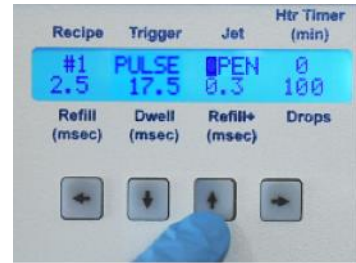
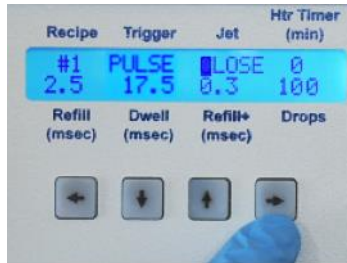

4. After the Jet Valve is open, the diaphragm can be inserted into the heater block.

First, align the diaphragm to the heater block using the rectangular grooves as shown in to the right. Gently press the diaphragm into the rectangular grooves until it is firmly in place.

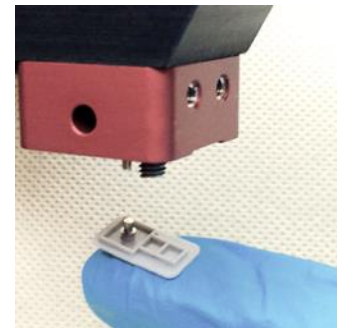
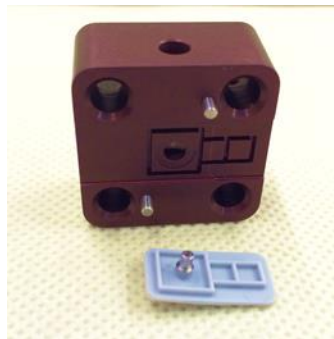

5. After the diaphragm is inserted, the nozzle plate can be attached to the heater.

- The nozzle plate has two locating pins to guide the nozzle plate onto the heater block.

Align the nozzle plate to the alignment pins on the heater block, with the fluid barb facing toward the fluid syringe.

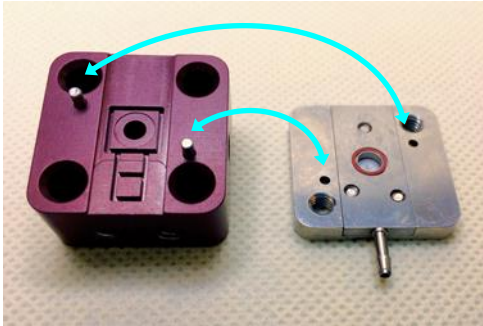

HEATER BLOCK
NOZZLE PLATE
FLUID BARB

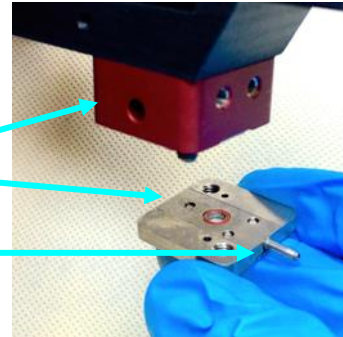

- Once the nozzle plate has been positioned on the heater block, it must be secured.

Tighten the two embedded screws with a 3 mm hex key. An optional torque wrench is available for this purpose (part no. NP09-2500).

Do not over-tighten; it is possible to strip the screws.



- Before installing the fluid syringe, set the Jet to CLOSE.

Recipe	Trigger	Jet	Htr Timer (min)
#1	PULSE	LOSE	0
2.5	17.5	0.3	100
Refill (msec)	Dwell (msec)	Refill+ (msec)	Drops

3.6 Install the Fluid Syringe

1. If the syringe is smaller than 30 cc, insert a syringe spacer ring; 3 cc, 5 cc, and 10 cc adapters are available.
2. Attach the feed tube to the syringe and place the syringe in the jet.

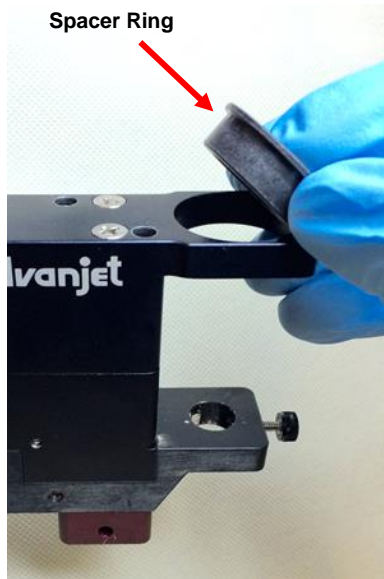

3. Slip the feed tube onto the barb end of the nozzle plate.
4. Install the receiver head.

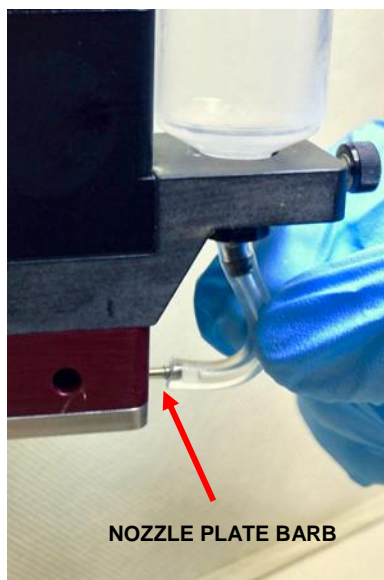





3.7 Prime the Jet

Note: The following procedures refer to the HV-2000C front panel functions.

1. Prior to dispensing, it is necessary to prime the jet in order to purge residual air from the system.

In order to do this, the fluid must be brought to dispensing temperature.

Turn on the heater and wait 10 minutes for the temperature of the nozzle to be stable. (From the HV-2000C front panel, use the following procedure.)

- Press  (INDEX) until Run-Stop (r-S) is displayed on the Present Value (PV) line.
- Use the   arrows to select the rUn setting on the Set Value (SV) line.
- Press  (ENTER) to save the change. Heater is ON.
- Press  again to return to the main screen



2. Turn the Fluid Air OFF (press “O” on Air switch).
3. Set **Jet** to OPEN.
4. Use the knob to turn **Fluid Pressure** down to **0**.



5. Turn the Fluid Air ON (press “I” on Air switch).
6. Place a substrate under the nozzle. While watching for fluid flow from the nozzle, slowly turn the **Fluid Air** knob to increase the pressure.

Once fluid begins to slowly flow, continue at that pressure until there are no bubbles in the fluid.

7. Set **Jet** to CLOSE.



8. Select a dispensing recipe for testing. On the HV-2000C Controller, the default values for Recipe #6 are normally used for this process.

Those parameters are set to:

- Refill = 10.0 ms
- Dwell = 10.0 ms
- Refill+ = 0.3 ms
- Drops = 250

Recipe	Trigger	Jet	Htr Timer (min)
#6	PULSE	CLOSE	0
10.0	10.0	0.3	250
Refill (msec)	Dwell (msec)	Refill+ (msec)	Drops

This recipe may not yield the best looking dispense, but it allows most fluids to flow through the jet easily.

9. Place a substrate under the nozzle and press the Trigger button to run the recipe once.
Observe the quality of the drops.
Repeat this 4 to 5 times to ensure the jet is properly primed.
10. Wipe the nozzle tip of any accumulation. The jet is ready to operate with the appropriate recipe settings.



3.8 Check for Fluid Leaks

NOTICE

If fluid leaks between the diaphragm and the nozzle plate, the jet will not function correctly. Dispensing should be discontinued and the components should be cleaned or replaced as required.

Before running a program, it is important to check for fluid leaks.

- Assemble the diaphragm and attach the nozzle plate to the jet (see Section 3.5).
- Fill a syringe with fluid and attach to the feed tube.
- Close the Jet valve, connect the receiver head to the syringe, and turn on the fluid air pressure.
- Set the fluid pressure to 10 psi (0.07 MPa) and the jet pressure to 45 psi (0.32 MPa).

Fluid should not drip through the orifice. If fluid is leaking through the nozzle tip when the Jet Valve is closed, check to see if the jet pressure is set to at least 35 psi (0.24 MPa). Increase the pressure to 60 psi (0.42 MPa) and check to see if the leak stops.

There are several areas to check for fluid leaks:

- Check to see if fluid leaks out of the weep hole in the heater block shown in Figure 3-3. If fluid is leaking, the diaphragm is either missing or damaged and should be replaced. The heater block will need to be removed and the leaking fluid should be cleaned.
- Fluid can leak out of the Luer fitting that attaches the syringe to the feed tube. Sometimes the Luer fitting is a little snug and hard to twist in completely. If fluid is leaking, give the fitting an extra turn to seat it completely. If this does not solve the leaking, change the feed tube and/or the syringe and check again.
- Fluid can leak at the junction between the feed tube and the nozzle plate inlet fitting. The feed tube is connected using a standard barb to the inlet fitting. If fluid is leaking at the barb end of the fitting, replace the feed tube.
- Check for leaks between the diaphragm and the nozzle plate. The nozzle plate must be attached correctly with screws well tightened. Make sure the Jet valve is closed. If you observe fluid leaking under the diaphragm, then the Jet has not been assembled correctly. Disassemble the dispensing components and inspect, clean, and/or replace the diaphragm as required.

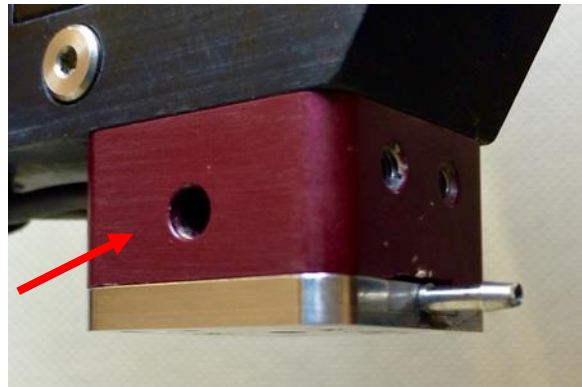





Figure 3-3: Check For Leaks at Weep Hole

If the leak continues, the diaphragm or nozzle plate is likely damaged or dirty, and it should be cleaned or replaced.

4. Cleaning the Jet

4.1 Cleaning the Exterior of the Jet

To clean the exterior of the jet, use a soft cotton or cellulose cloth. If the jet exterior is extremely dirty, a small amount of alcohol can be used.

				
To avoid personal injury, move the nozzle close to the paper so there is minimal misting of the solvent during flushing. Be sure there is proper ventilation and wear appropriate eye and skin protection as instructed by the solvent manufacturer.				

NOTICE

Do not use a dripping wet cloth and do not pour solvents, alcohol, water, or other liquids directly on the jet. Also, do not submerge the jet in the cleaning agent as the jet could be damaged.

4.2 Cleaning the Interior of the Jet

The Advanjet HV-2000 is a high precision jet for dispensing minute amounts of fluid. Dispensing nozzles can become blocked or clogged by the smallest contaminants, which will adversely affect dispensing results. Symptoms of a contaminated jet are:

- Unclean or uneven dispensing.
- Drops become irregular or vary in size.
- Residual flow or drooling out of the tip when the jet is in the closed position.
- Interrupted dispensing (places where fluid no longer is dispensed).
- Splatter or satellites.

The importance of clean jetting is a key design element of the HV-2000, resulting in a jet that is quick and easy to clean.

NOTICE

It is important to first turn off the air switch before cleaning the jet. If not, the fluid from the syringe will make a mess if the feed tube is dismounted under pressure.

Follow these simple cleaning steps to optimize jetting quality and maximize productivity.

1. Turn the Fluid **Air** OFF (press “O” on the **Air** switch).



2. Remove the receiver head.
3. Remove the feed tube from the nozzle plate.
4. Remove the syringe from the jet.

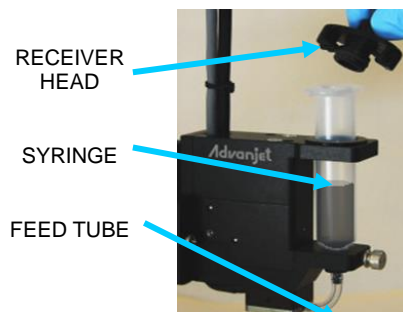

5. Install an empty syringe with a feed tube onto the fluid barb of the nozzle plate.
6. Fill the syringe with about 3 cc of mild solvent compatible with your fluid material.
7. Install the receiver head onto the syringe.

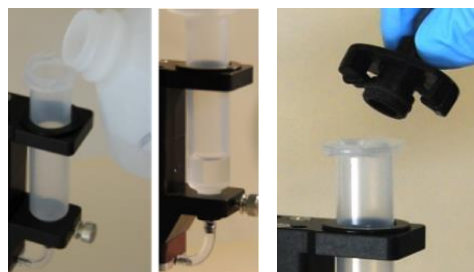

8. Select Recipe #6
Recipe #6 is pre-programmed for:
 - 10.0 msec Refill
 - 10.0 msec Dwell
 - 0.3 msec Refill+
 - 250 Drops.

Recipe	Trigger	Jet	Htr Timer (min)
#6	PULSE	CLOSE	0
10.0	10.0	0.3	250
Refill (msec)	Dwell (msec)	Refill+ (msec)	Drops

Turn the **Fluid Air** ON (press “I” on **Air** switch).

9. Place a paper towel or aluminum-foil dish under the nozzle.



<p>To avoid personal injury, move the nozzle close to the paper so there is minimal misting of the solvent during flushing. Be sure there is proper ventilation and wear appropriate eye and skin protection as instructed by the solvent manufacturer.</p>				

10. Press the **Trigger** button to run Recipe #6.
 - Continue to press the **Trigger** button until the liquid coming out of the nozzle is clear and clean, or all 3 cc of the solvent is flushed. It normally requires about 5 or 6 flushes of 250 drops.
 - If there is too much solvent in the syringe, you can open the jet to let out the remaining solvent.

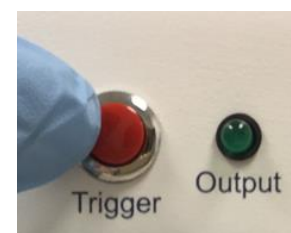

Note: it is easier to work with an empty syringe – let the remaining solvent drain completely to manage the solvent in the cleanest way.

4.3 Clean the Nozzle and Nozzle Plate

1. Turn the **Fluid Air** OFF (press “O” on **Air** switch).
2. Remove the flushing syringe.
3. Remove the nozzle plate with the 3 mm hex driver.
4. Remove the diaphragm from the heater block.
5. Inspect if the diaphragm or nozzle plate requires further cleaning. Normally, the flushing process achieves 90% clean.
6. Hand clean the diaphragm with mild solvent such as rubbing alcohol and a brush. A suitable cleaning brush, pictured above, can be ordered from Advanjet (part number CLB-01).
7. The nozzle plate can be cleaned with a stronger solvent than the one used for the diaphragm. If necessary, insert the nozzle plate in a small container of acetone or isopropanol alcohol and immerse the container in an ultrasonic cleaner for 10 minutes. If necessary, repeat a second time. Do not submerge the nozzle plate for extended periods of time.



NOTICE

Never submerge the diaphragm in solvents as they might be damaged.

Diaphragms can be cleaned successfully with a small amount of solvent and a soft brush and cotton swab.

Do not submerge the diaphragm into the ultrasonic cleaner because it will deteriorate the diaphragm and shorten its life.

8. When the ultrasonic cleaning is finished, remove the nozzle from its container and wrap it in a paper towel, making sure the barb is still exposed. Use an air hose to cover the barb and blow air through the plate for about 3 seconds (see below left).
9. Using the tools in the Advanjet cleaning kit (P/N CL-XXX; XXX = nozzle size), pass the cleaning drill through the nozzle plate barb to scrape out excess material (see below center). Use the air hose again to blow out loosened material.
10. To make sure the nozzle is absolutely clean, run a cleaning wire through the nozzle (photo below). Make sure it is the correct size and that it is able to pass through the hole. If not, either the wire is too big or the nozzle is still clogged. Repeat ultrasonic cleaning, blowing out, and cleaning with the drill and wire.

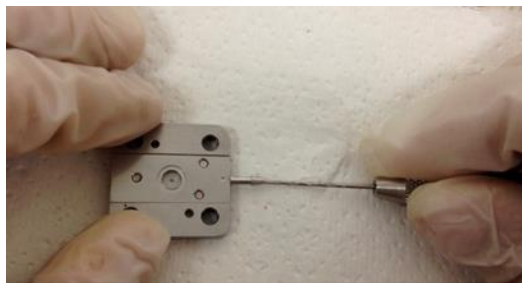

Graco Standard Warranty

Graco warrants all equipment referenced in this document which is manufactured by Graco and bearing its name to be free from defects in material and workmanship on the date of sale to the original purchaser for use. With the exception of any special, extended, or limited warranty published by Graco, Graco will, for a period of twelve months from the date of sale, repair or replace any part of the equipment determined by Graco to be defective. This warranty applies only when the equipment is installed, operated and maintained in accordance with Graco's written recommendations.

This warranty does not cover, and Graco shall not be liable for general wear and tear, or any malfunction, damage or wear caused by faulty installation, misapplication, abrasion, corrosion, inadequate or improper maintenance, negligence, accident, tampering, or substitution of non-Graco component parts. Nor shall Graco be liable for malfunction, damage or wear caused by the incompatibility of Graco equipment with structures, accessories, equipment or materials not supplied by Graco, or the improper design, manufacture, installation, operation or maintenance of structures, accessories, equipment or materials not supplied by Graco.

This warranty is conditioned upon the prepaid return of the equipment claimed to be defective to an authorized Graco distributor for verification of the claimed defect. If the claimed defect is verified, Graco will repair or replace free of charge any defective parts. The equipment will be returned to the original purchaser transportation prepaid. If inspection of the equipment does not disclose any defect in material or workmanship, repairs will be made at a reasonable charge, which charges may include the costs of parts, labor, and transportation.

THIS WARRANTY IS EXCLUSIVE, AND IS IN LIEU OF ANY OTHER WARRANTIES, EXPRESS OR IMPLIED, INCLUDING BUT NOT LIMITED TO WARRANTY OF MERCHANTABILITY OR WARRANTY OF FITNESS FOR A PARTICULAR PURPOSE.

Graco's sole obligation and buyer's sole remedy for any breach of warranty shall be as set forth above. The buyer agrees that no other remedy (including, but not limited to, incidental or consequential damages for lost profits, lost sales, injury to person or property, or any other incidental or consequential loss) shall be available. Any action for breach of warranty must be brought within two (2) years of the date of sale.

GRACO MAKES NO WARRANTY, AND DISCLAIMS ALL IMPLIED WARRANTIES OF MERCHANTABILITY AND FITNESS FOR A PARTICULAR PURPOSE, IN CONNECTION WITH ACCESSORIES, EQUIPMENT, MATERIALS OR COMPONENTS SOLD BUT NOT MANUFACTURED BY GRACO. These items sold, but not manufactured by Graco (such as electric motors, switches, hose, etc.), are subject to the warranty, if any, of their manufacturer. Graco will provide purchaser with reasonable assistance in making any claim for breach of these warranties.

In no event will Graco be liable for indirect, incidental, special or consequential damages resulting from Graco supplying equipment hereunder, or the furnishing, performance, or use of any products or other goods sold hereto, whether due to a breach of contract, breach of warranty, the negligence of Graco, or otherwise.

FOR GRACO CANADA CUSTOMERS

The Parties acknowledge that they have required that the present document, as well as all documents, notices and legal proceedings entered into, given or instituted pursuant hereto or relating directly or indirectly hereto, be drawn up in English. Les parties reconnaissent avoir convenu que la rédaction du présente document sera en Anglais, ainsi que tous documents, avis et procédures judiciaires exécutés, donnés ou intentés, à la suite de ou en rapport, directement ou indirectement, avec les procédures concernées.

Graco Information

Sealant and Adhesive Dispensing Equipment

For the latest information about Graco products, visit www.graco.com.

For patent information, see www.graco.com/patents.

For customer service and technical assistance, e-mail info@advanjet.com

TO PLACE AN ORDER, contact your Graco distributor, go to www.graco.com and select "Where to Buy" in the top blue bar, or call to find the nearest distributor.

If calling from the US: 800-333-4877

If calling from outside the US: +1-760-294-3392

All written and visual data contained in this document reflects the latest product information available at the time of publication.

Graco reserves the right to make changes at any time without notice.

Original instructions. This manual contains English. MM 3A5855

Graco Headquarters: Minneapolis

International Offices: Belgium, China, Japan, Korea

GRACO INC. AND SUBSIDIARIES • P.O. BOX 1441 • MINNEAPOLIS MN 55440-1441 • USA

Copyright 2016, Graco Inc. All Graco manufacturing locations are registered to ISO 9001.